

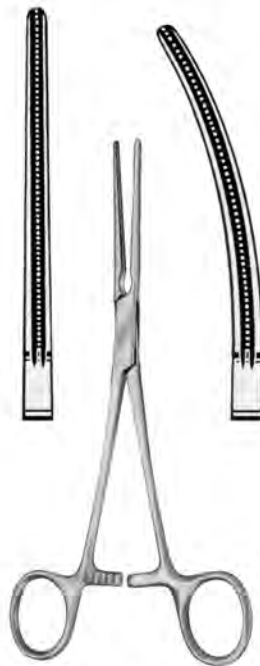

cm — HALSTEAD-MOSQUITO — cm
 12,0 **BD2800.12** **BD2801.12**
 15,0 **BD2800.5** **BD2801.15**

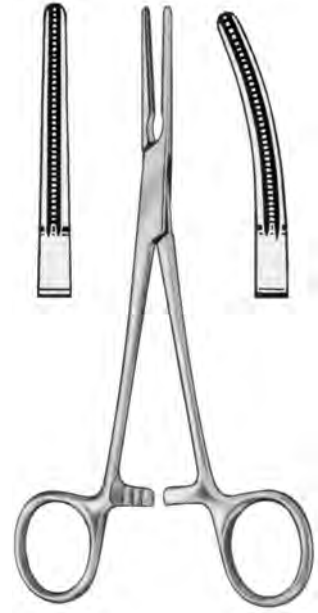

cm — PEAN — cm
 14,0 **BD2802.14** **BD2803.14**
 16,0 **BD2802.16** **BD2803.16**
 18,0 **BD2802.18** **BD2803.18**
 20,0 **BD2802.20** **BD2803.20**



cm — RANKIN — cm
 16,0 **BD2804.16** **BD2805.16**

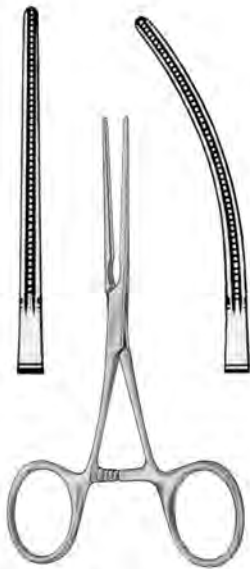

cm — DE BAKEY — cm
 12,0 **BD2012.12** **BD2013.12**

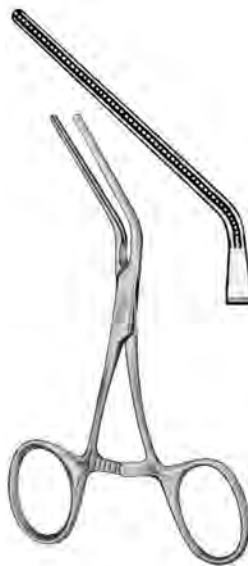

DE BAKEY
BD2111.12
 12,0 cm



DE BAKEY
BD2113.12
 12,0 cm

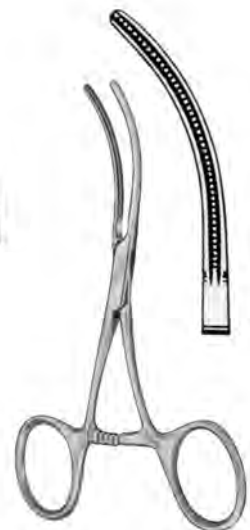

DE BAKEY
BD2211.12
 12,0 cm

Bronchusklemmen
Bronchus Forceps
Pincers-Clamps à Bronches
Pinzas clamps bronquiales
Pinze per bronchi



cm	LEES
23,0	BD2311.23
25,0	BD2311.25

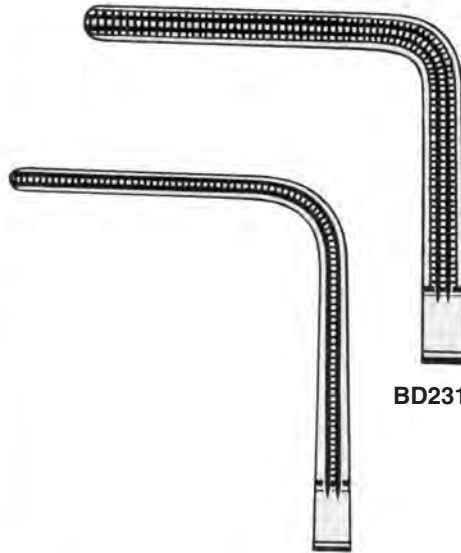

BD2311.25

BD2311.23



LEES
BD2313.25
25,0 cm

Coarctationsklemmen
 Coarction Clamps
 Pincas à coarctacion
 Pinzas para coarctación
 Pinze per coartazione

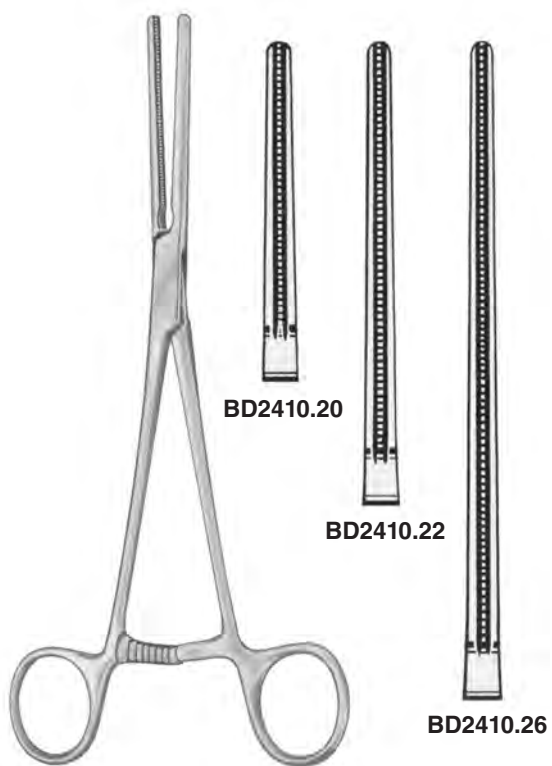

cm	POTTS
20,0	BD2410.20
22,5	BD2410.22
26,0	BD2410.26

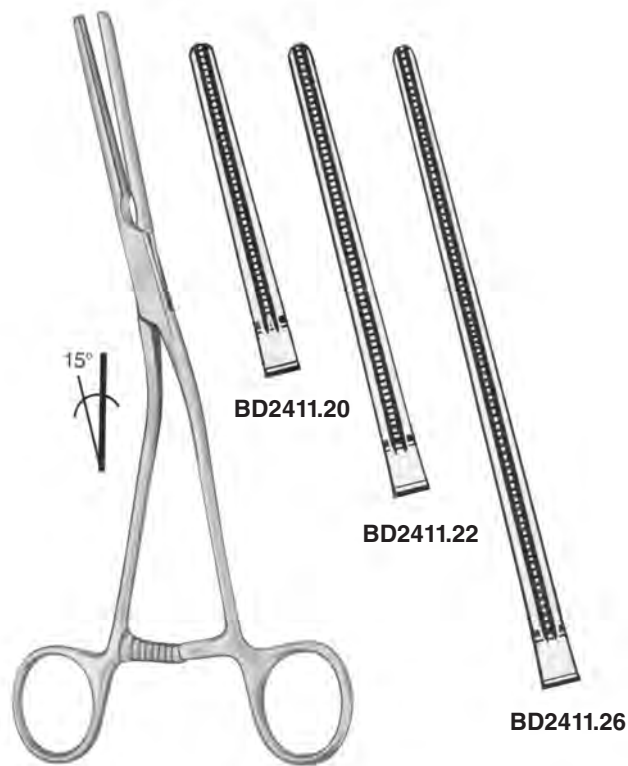

cm	GLOVER
20,0	BD2411.20
22,5	BD2411.22
26,0	BD2411.26

Anastomosenklemmen
 Anastomosis Clamps
 Pincès à anastomose
 Pinzas para anastomosis
 Pinze per anastomosi



cm	POTTS / GLOVER
21,0	BD2511.21
24,0	BD2511.24



BD2511.21 **BD2511.24**



cm	GLOVER
18,0	BD2513.18
22,0	BD2513.22

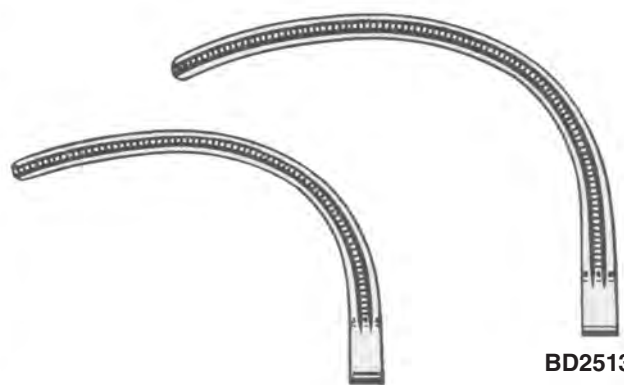

BD2513.18 **BD2513.22**

Atraumatische Gefäßklemmen
 Atraumatic Hemostatic Forceps
 Pincés hémostatiques atraumatiques
 Pinzas hemostáticas atraumáticas
 Pinze emostatiche atraumatiche

Vascularklemme löffelförmig
 Vascular Clamps Spoon Shaped
 Pince vasculaire forme cuiller
 Pinza vascular forma cuchara
 Pinza vascolare forma cucchiaio

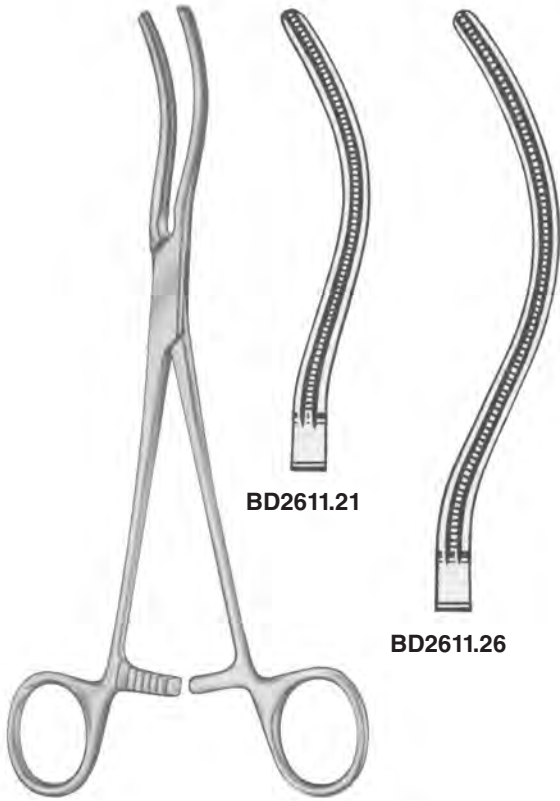

cm	GLOVER
21,0	BD2611.21
26,0	BD2611.26

Peripher-Vascularklemmen
 Peripheral Vascular Forceps
 Pincés vasculaires périph.
 Pinzas vasculares perif.
 Pinze vascolari perif.

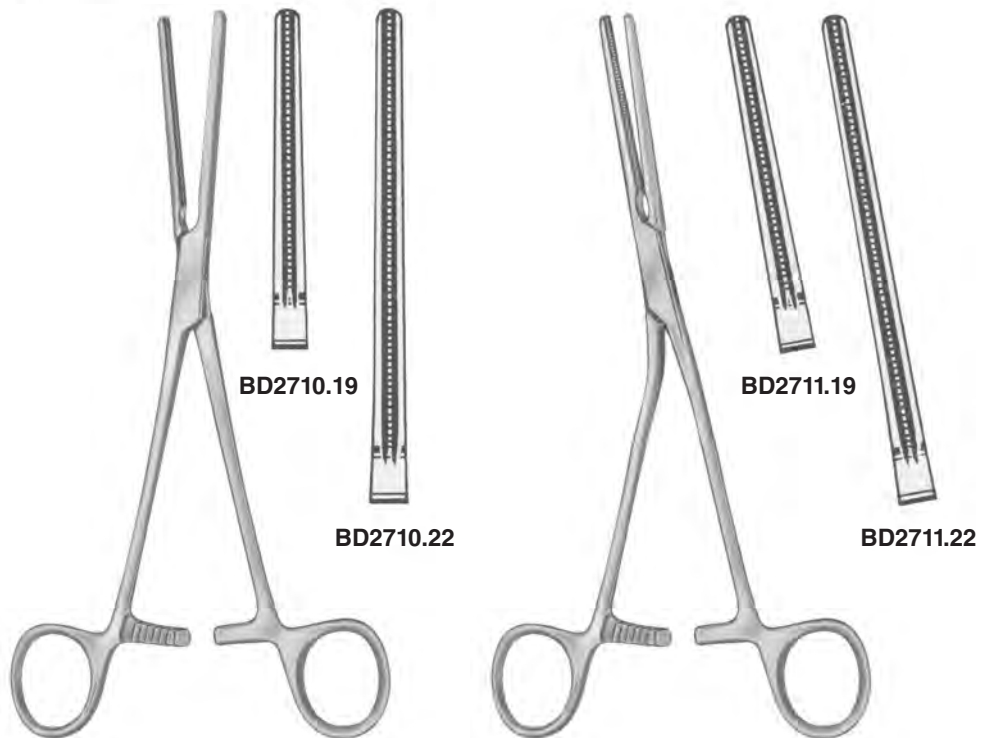

cm	DE BAKEY
18,0	BD2710.19
22,0	BD2710.22

cm	DE BAKEY
18,0	BD2711.19
22,0	BD2711.22

Atraumatische Gefäßklemmen
 Atraumatic Hemostatic Forceps
 Pinces hémostatiques atraumatiques
 Pinzas hemostáticas atraumáticas
 Pinze emostatiche atraumatiche

Atraumatische Mehrweckklemmen
 Atraumatic Multi-Purpose Clamps
 Pinces-clamps polyvalentes
 Pinzas clamps para usos varios
 Pinze atraumatiche per diversi usi



DARDIK

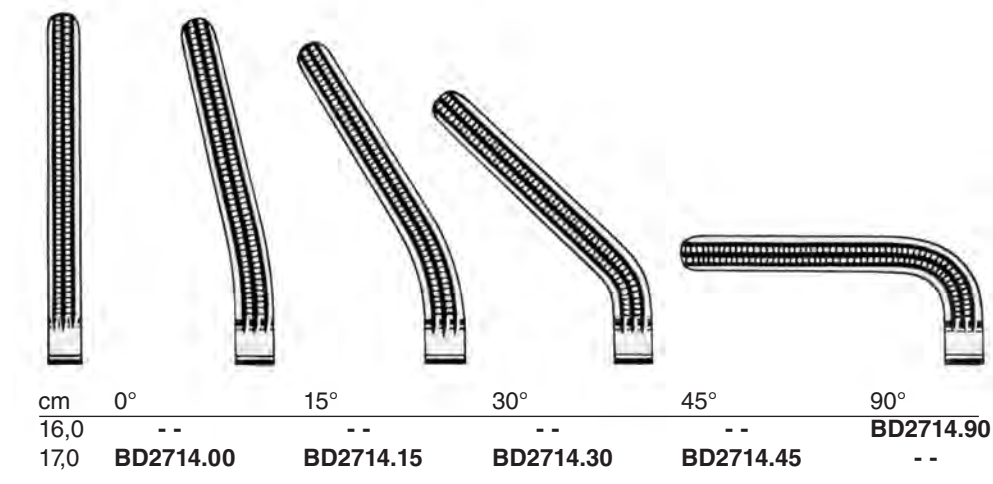
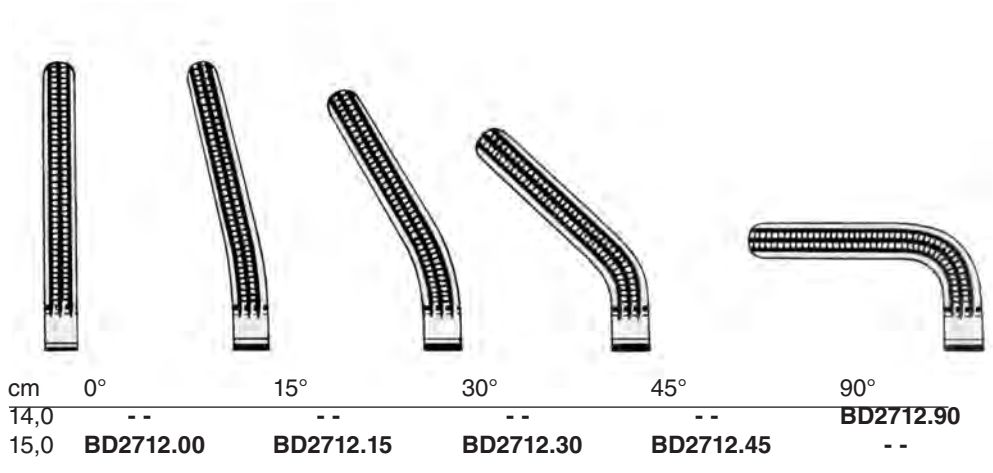

Atraumatische Gefäßklemmen
 Atraumatic Hemostatic Forceps
 Pincès hémostatiques atraumatiques
 Pinzas hemostáticas atraumáticas
 Pinze emostatiche atraumatiche

Peripher-Vascularklemmen
 Peripheral Vascular Forceps
 Pincès vasculaires périph.
 Pinzas vasculares perif.
 Pinze vascolari perif.



LELAND-JONES
BD2811.19
 19,0 cm



DE BAKEY
BD2811.26
 26,0 cm

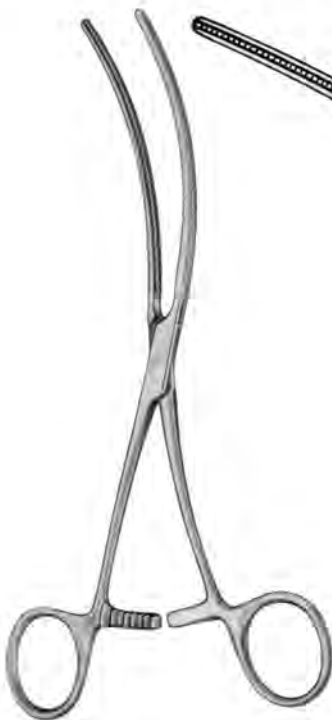

cm	DE BAKEY
19,0	BD2813.19
20,0	BD2813.20

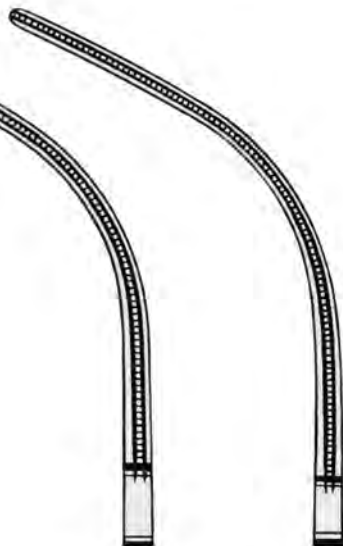

BD2813.19 **BD2813.20**



DE BAKEY
BD2911.16
 16,0 cm

Atraumatische Gefäßklemmen
 Atraumatic Hemostatic Forceps
 Pincès hémostatiques atraumatiques
 Pinzas hemostáticas atraumáticas
 Pinze emostatiche atraumatiche



BAINBRIDGE



BD2916.15
15,0 cm



BD2916.18
18,0 cm



BD2917.15
15,0 cm



BD2917.18
18,0 cm

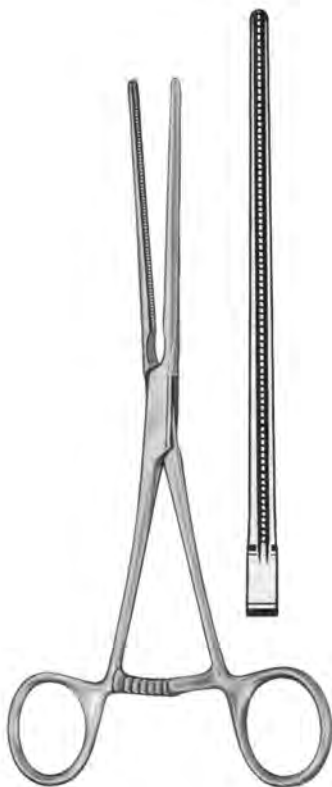

LELAND JONES
BD2022.19
 19,0 cm

Peripher-Vascularklemmen
 Peripheral Vascular Forceps
 Pincès vasculaires périph.
 Pinzas vasculares perif.
 Pinze vascolari perif.



BD2023.19
19,0 cm

BD2025.19
19,0 cm

LELAND JONES

Atraumatische Gefäßklemmen
Atraumatic Hemostatic Forceps
Pinces hémostatiques atraumatiques
Pinzas hemostáticas atraumáticas
Pinze emostatiche atraumatiche

Aortaklemmen
Aortic Clamp
Pince-clamp à aorte
Pinza clamp para aorta
Pinza per aorta



LIDDLE
BD2029.27
27,0 cm



Aorta-Anastomosenklemmen
Aorta-Anastomosis Clamps
Pinces-clamps pour anastomoses d'aorte
Pinzas clamps para anastomosis de aorta
Pinze aortiche



LAMBERT KAY
BD2121.20
20,0 cm

Atraumatische Gefäßklemmen
Atraumatic Hemostatic Forceps
Pinces hémostatiques atraumatiques
Pinzas hemostáticas atraumáticas
Pinze emostatiche atraumatiche

Iliaca-Klemme
Iliac Clamp
Pince-clamp à iliaque
Pinza clamp para iliaca
Pinza per iliaca

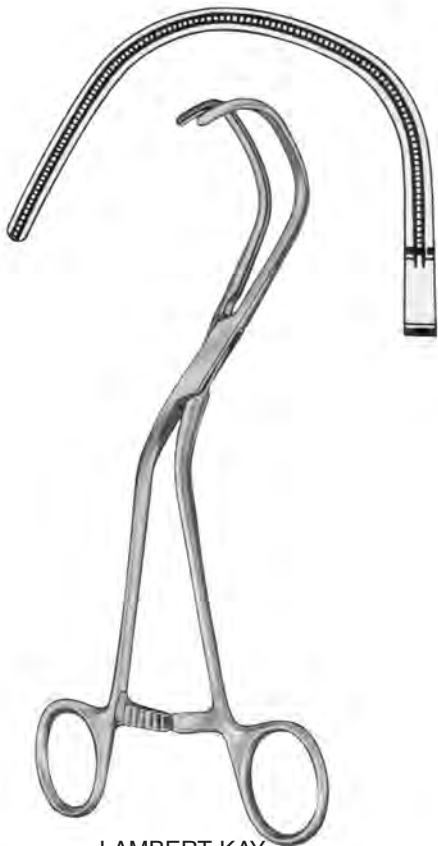

LAMBERT KAY
BD2123.20
20,0 cm



DE BAKEY
BD2125.20
20,0 cm

Atraumatische Gefäßklemmen
Atraumatic Hemostatic Forceps
Pinces hémostatiques atraumatiques
Pinzas hemostáticas atraumáticas
Pinze emostatiche atraumatiche



links gebogen
curved to left
courbe à gauche
curva a la izquierda
curva a sinistra



WEBER
BD2127.26
26,0 cm



rechts gebogen
curved to right
courbe à droite
curva a la derecha
curva a destra



WEBER
BD2129.26
26,0 cm

Atraumatische Gefäßklemmen
Atraumatic Hemostatic Forceps
Pinces hémostatiques atraumatiques
Pinzas hemostáticas atraumáticas
Pinze emostatiche atraumatiche

Aorta-Aneurysma-Klemmen
Aorta-Aneurysm Clamps
Pinces-clamps pour aneurysme d'aorte
Pinzas clamps para aneurisma de aorta
Pinze per aneurisma di aorta



DE BAKY

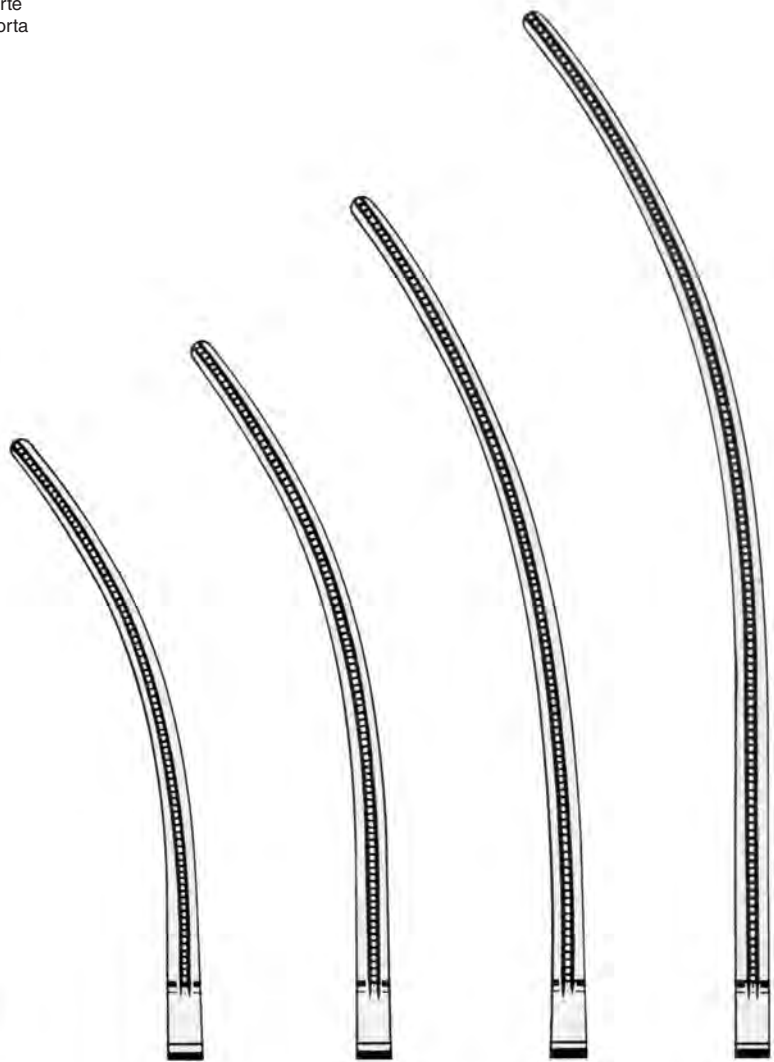

BD2221.24
24,0 cm

BD2221.27
27,0 cm

BD2221.31
31,0 cm

BD2221.35
35,0 cm

Atraumatische Gefäßklemmen
Atraumatic Hemostatic Forceps
Pinces hémostatiques atraumatiques
Pinzas hemostáticas atraumáticas
Pinze emostatiche atraumatiche

Aorta-Aneurysma-Klemmen
Aorta-Aneurysm Clamps
Pinces-clamps pour aneurysme d'aorte
Pinzas clamps para aneurisma de aorta
Pinze per aneurisma di aorta



DE BAKEY BAHNSON



BD2223.24
24,0 cm

BD2223.25
25,0 cm

BD2223.26
26,0 cm

Atraumatische Gefäßklemmen
Atraumatic Hemostatic Forceps
Pinces hémostatiques atraumatiques
Pinzas hemostáticas atraumáticas
Pinze emostatiche atraumatiche

Aorta-Aneurysma-Klemmen
Aorta-Aneurysm Clamps
Pinces-clamps pour aneurysme d'aorte
Pinzas clamps para aneurisma de aorta
Pinze per aneurisma di aorta

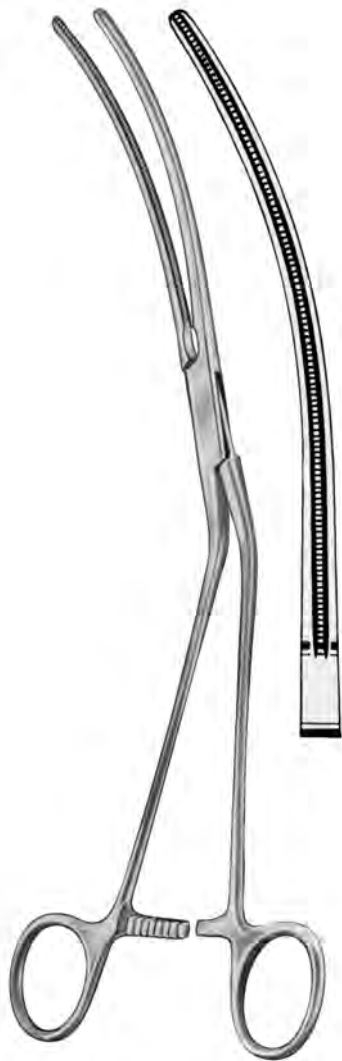

DE BAKEY
BD2225.28
28,0 cm

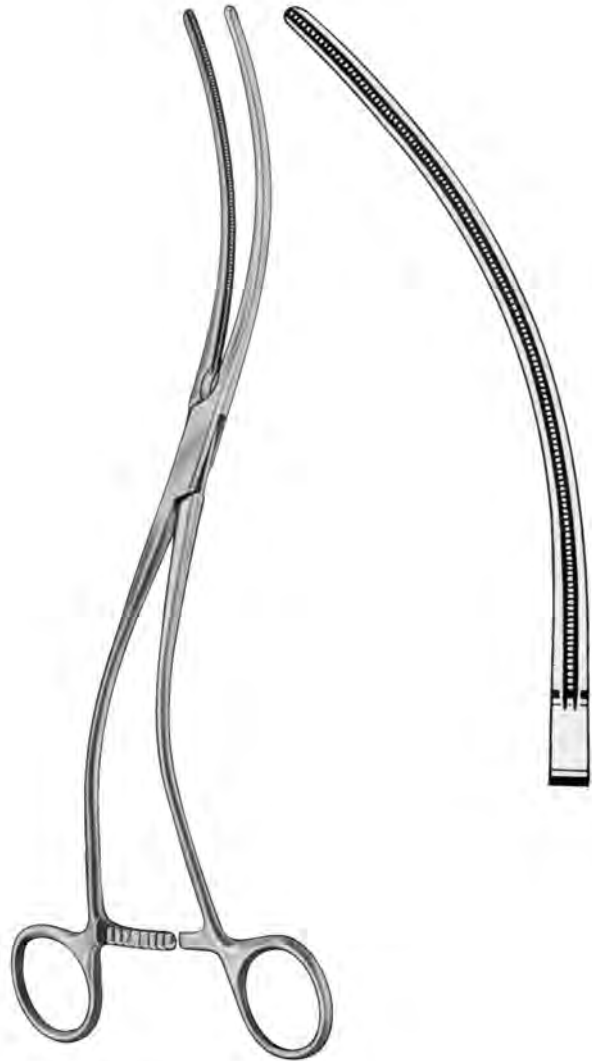

DE BAKEY
BD2227.28
28,0 cm

Atraumatische Gefäßklemmen
Atraumatic Hemostatic Forceps
Pinces hémostatiques atraumatiques
Pinzas hemostáticas atraumáticas
Pinze emostatiche atraumatiche

Atraumatische Mehrzweckklemmen
Atraumatic Multi-Purpose Clamps
Pinces-clamps polyvalentes
Pinzas clamps para usos varios
Pinze atraumatiche per diversi usi



DE BAKEY MORRIS

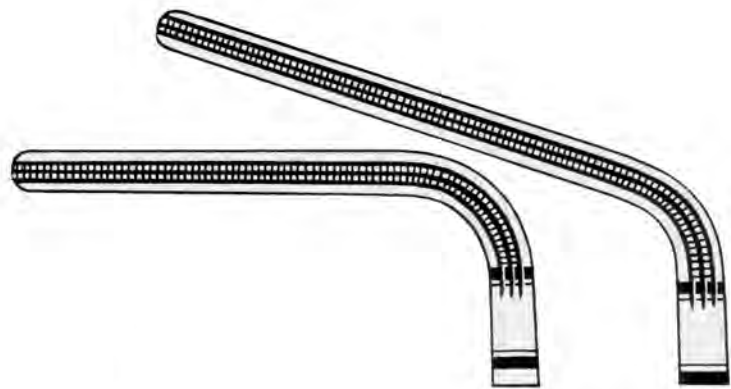

BD2229.18
18,0 cm

BD2229.20
20,0 cm

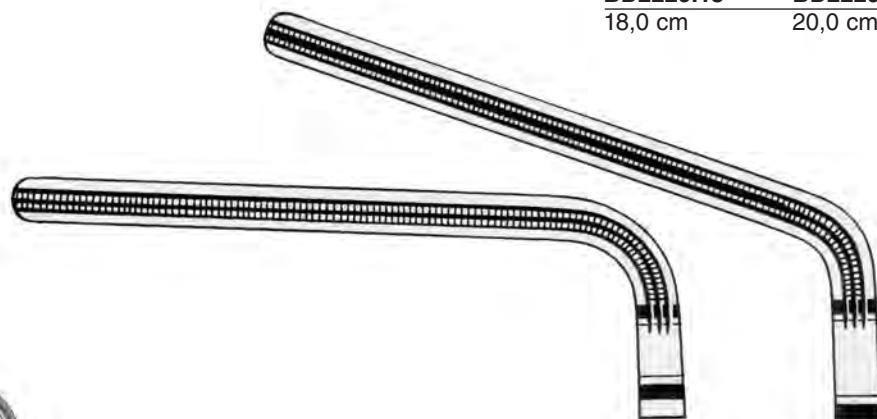

BD2229.23
23,0 cm

BD2229.25
25,0 cm

Atraumatische Gefäßklemmen
Atraumatic Hemostatic Forceps
Pinces hémostatiques atraumatiques
Pinzas hemostáticas atraumáticas
Pinze emostatiche atraumatiche

Atraumatische Mehrweckklemmen
Atraumatic Multi-Purpose Clamps
Pinces-clamps polyvalentes
Pinzas clamps para usos varios
Pinze atraumatiche per diversi usi



DE BAKEY



BD2321.18
18,0 cm

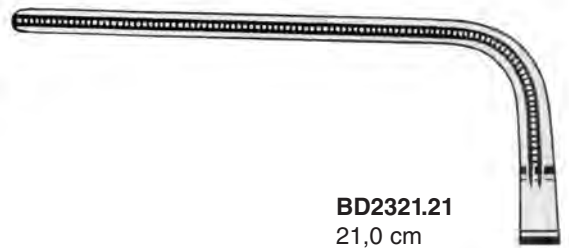

BD2321.21
21,0 cm

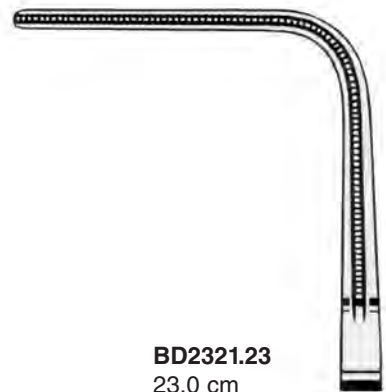

BD2321.23
23,0 cm



BD2321.27
27,0 cm

Atraumatische Gefäßklemmen
Atraumatic Hemostatic Forceps
Pincés hémostatiques atraumatiques
Pinzas hemostáticas atraumáticas
Pinze emostatiche atraumatiche

Aorta-Aneurysma-Klemmen
Aorta-Aneurysm Clamps
Pincés-clamps pour aneurysme d'aorte
Pinzas clamps para aneurisma de aorta
Pinze per aneurisma di aorta



DE BAKEY

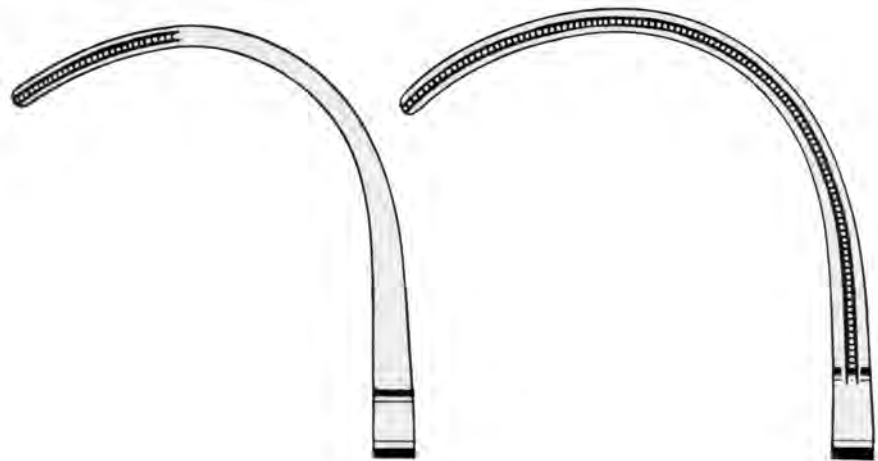

BD2421.25
25,0 cm

BD2421.26
26,0 cm

Atraumatische Gefäßklemmen
Atraumatic Hemostatic Forceps
Pincés hémostatiques atraumatiques
Pinzas hemostáticas atraumáticas
Pinze emostatiche atraumatiche

Bronchus-Klemmen
Bronchus Clamps
Pincés pour les bronches
Pinzas bronquiales
Pinze per bronchi



DE BAKEY
BD2427.27
27,0 cm

Atraumatische Gefäßklemmen
 Atraumatic Hemostatic Forceps
 Pincés hémostatiques atraumatiques
 Pinzas hemostáticas atraumáticas
 Pinze emostatiche atraumatiche



DE BAKEY

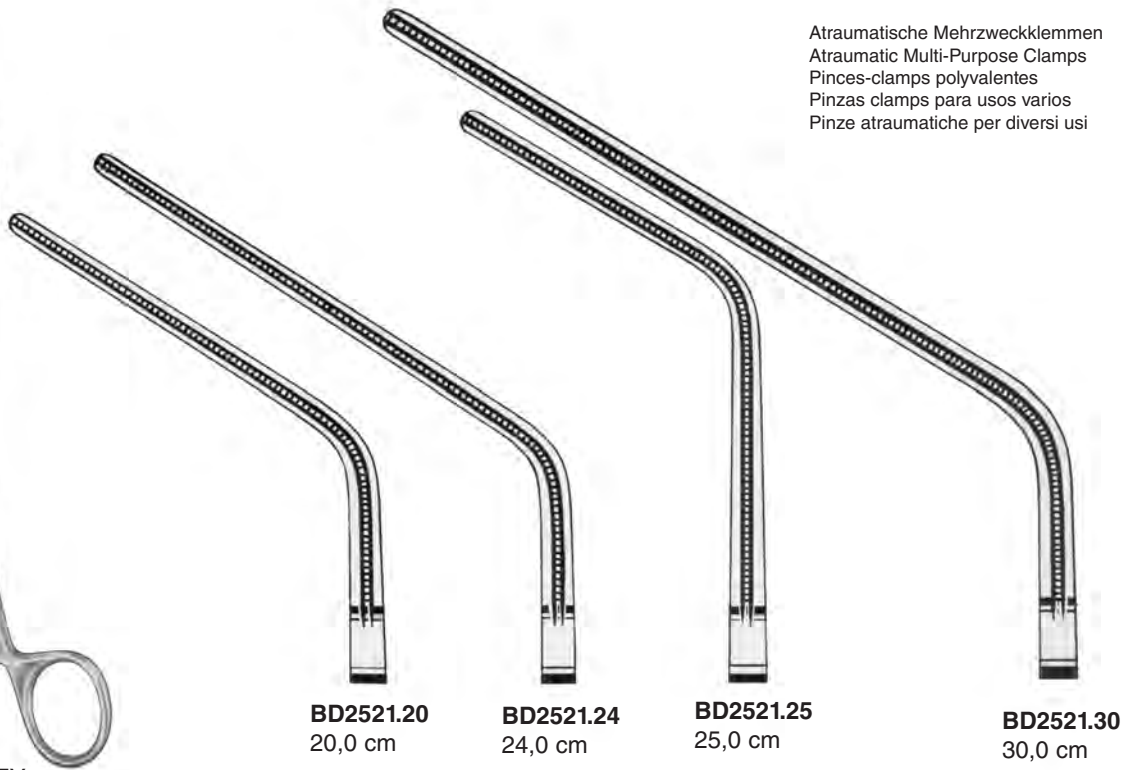

Atraumatische Mehrzweckklemmen
 Atraumatic Multi-Purpose Clamps
 Pincés-clamps polyvalentes
 Pinzas clamps para usos varios
 Pinze atraumatiche per diversi usi

BD2521.20
20,0 cm

BD2521.24
24,0 cm

BD2521.25
25,0 cm

BD2521.30
30,0 cm



SATINSKY

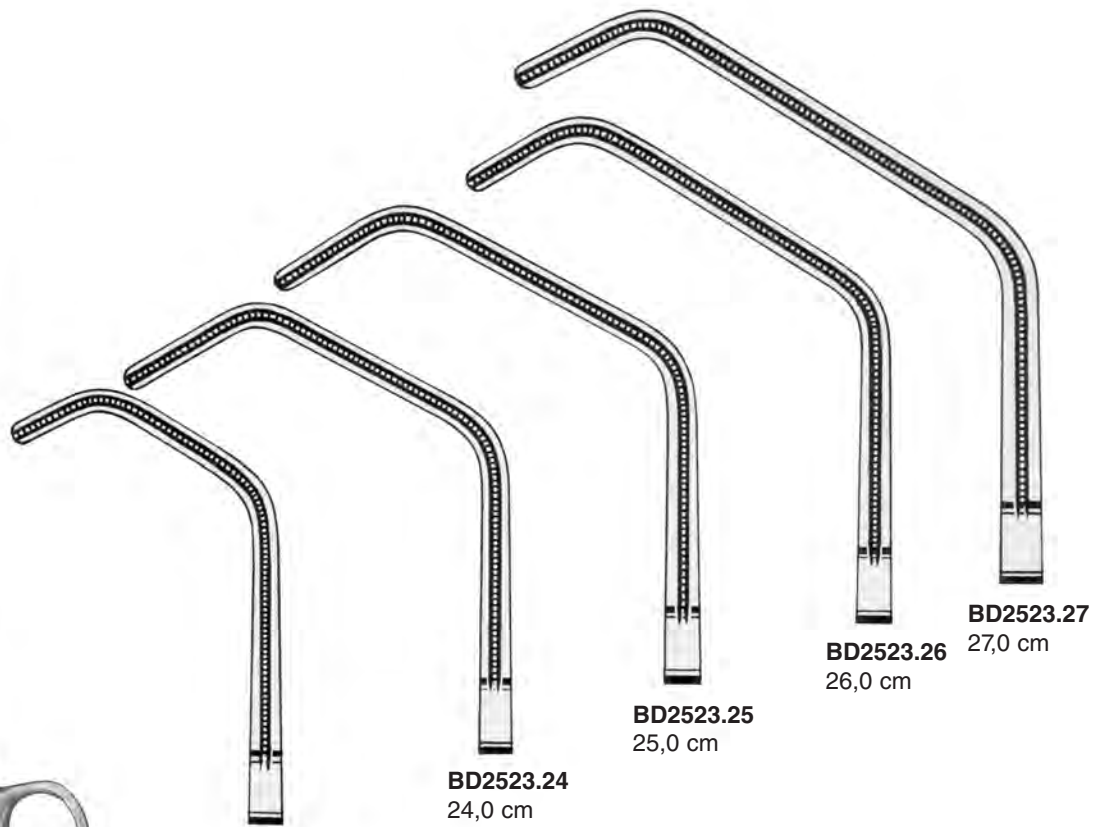

BD2523.20
20,0 cm

BD2523.24
24,0 cm

BD2523.25
25,0 cm

BD2523.26
26,0 cm

BD2523.27
27,0 cm

Atraumatische Gefäßklemmen
 Atraumatic Hemostatic Forceps
 Pinces hémostatiques atraumatiques
 Pinzas hemostáticas atraumáticas
 Pinze emostatiche atraumatiche

Anlegezange für Clips
 Applying for Clips
 Appicateur pour clips
 Pinza para aplicar clips
 Applicatore per clips

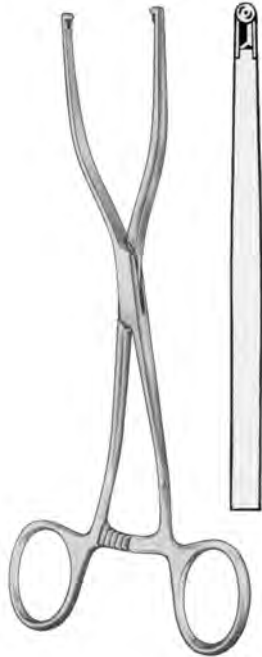

EDWARDS
 BD2528.00

Clips
 Clips
 Clips
 Clips
 Clips



mm	EDWARDS
6	BD2528.06
12	BD2528.12



WYLIE

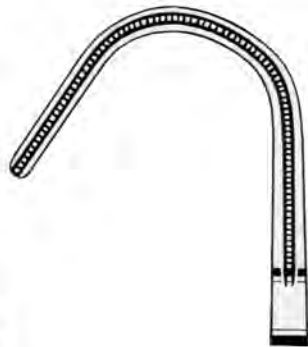

BD2529.01
 Fig. 1
 21,0 cm

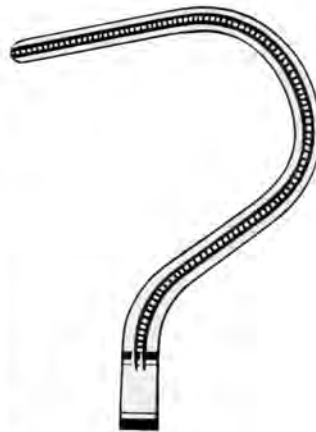

BD2529.02
 Fig. 2
 22,0 cm

Atraumatische Gefäßklemmen
Atraumatic Hemostatic Forceps
Pincés hémostatiques atraumatiques
Pinzas hemostáticas atraumáticas
Pinze emostatiche atraumatiche



DE BAKEY SATINSKY

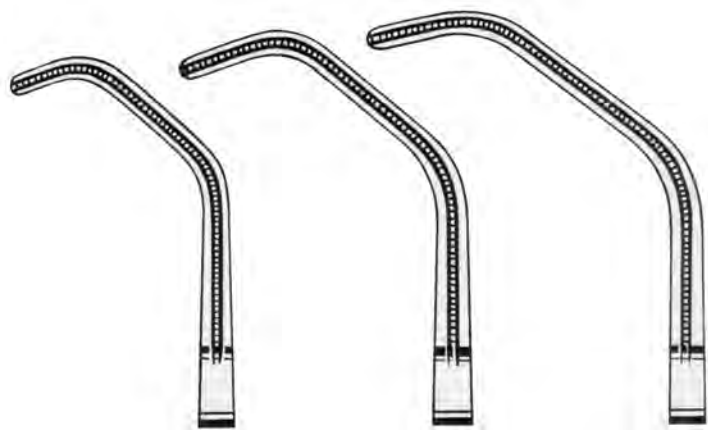

BD2621.23
Fig. 1
23,0 cm

BD2621.24
Fig. 2
24,0 cm

BD2621.25
Fig. 3
25,0 cm

Atraumatische Gefäßklemmen
Atraumatic Hemostatic Forceps
Pinces hémostatiques atraumatiques
Pinzas hemostáticas atraumáticas
Pinze emostatiche atraumatiche

Aurikelklemmen
Auricle Clamps
Pinces auriculaires
Pinzas para aurícula
Pinze ventricolari



HARKEN



BD2623.25
Fig. 1
25,0 cm



BD2625.24
Fig. 2
24,0 cm



BD2627.24
Fig. 3
24,0 cm

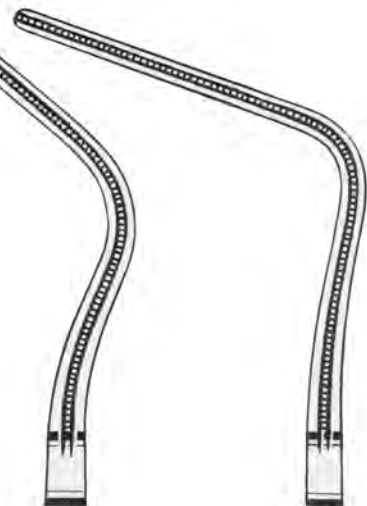

BD2629.24
Fig. 4
24,0 cm

Atraumatische Gefäßklemmen
Atraumatic Hemostatic Forceps
Pincés hémostatiques atraumatiques
Pinzas hemostáticas atraumáticas
Pinze emostatiche atraumatiche

Peripheal-Gefäßklemmen
Peripheal Vascular Clamps
Pincés-clamps, vasculaires périphériques
Pinzas para vasos periféricos
Pinze vascolari periferali

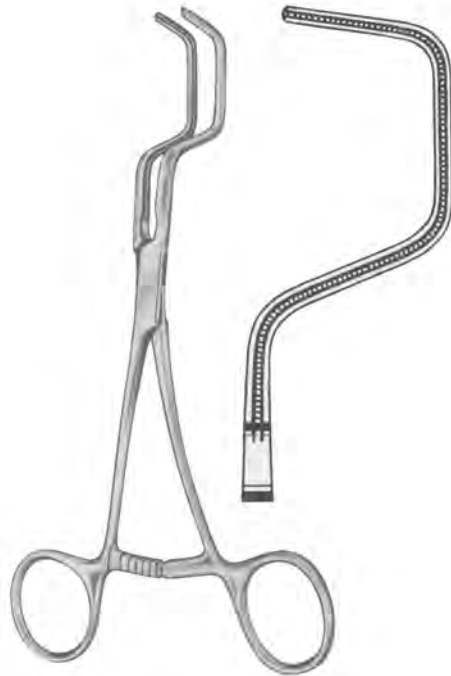

DALE
BD2721.18
18,0 cm



DALE

BD2723.17
17,0 cm

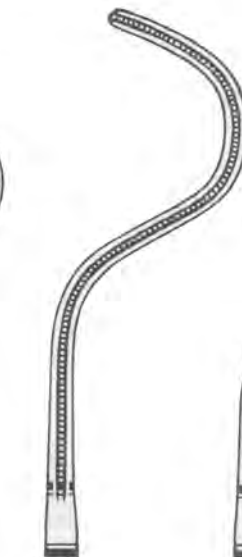

BD2723.18
18,0 cm

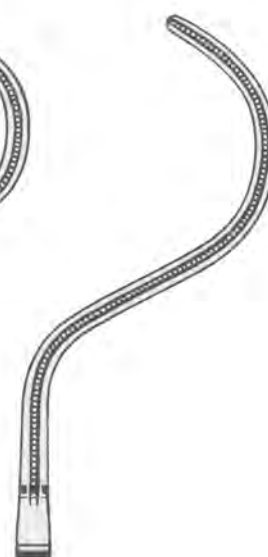

BD2723.19
19,0 cm

Atraumatische Gefäßklemmen
 Atraumatic Hemostatic Forceps
 Pinces hémostatiques atraumatiques
 Pinzas hemostáticas atraumáticas
 Pinze emostatiche atraumatiche



DE BAKEY
BD2821.17
 17,0 cm



BECK
BD2823.17
 17,0 cm

Präparier- und Ligaturklemmen
 Dissecting and Ligature Clamps
 Pinces à dissection et passe-fil
 Pinzas de disección y para ligaduras
 Pinze per dissezione e per legature

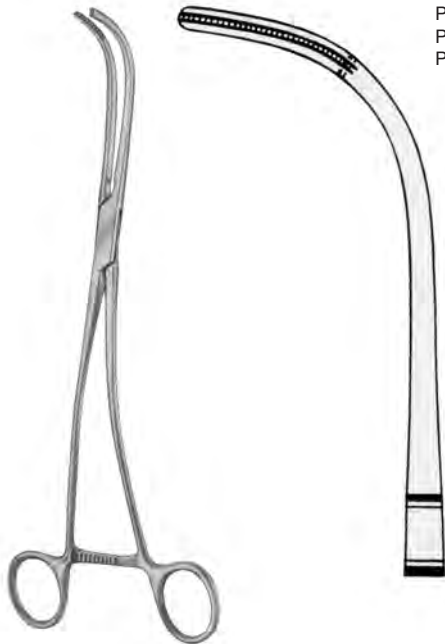

DE BAKEY
BD2825.24
 24,0 cm



DE BAKEY
BD2827.24
 24,0 cm

Atraumatische Gefäßklemmen
Atraumatic Hemostatic Forceps
Pincés hémostatiques atraumatiques
Pinzas hemostáticas atraumáticas
Pinze emostatiche atraumatiche

Atraumatische Mehrzweckklemmen
Atraumatic Multi-Purpose Clamps
Pincés-clamps polyvalentes
Pinzas clamps para usos varios
Pinze atraumatiche per diversi usi



POTTS



BD2828.21
21,0 cm



BD2828.23
23,0 cm



BD2828.27
27,0 cm



BD2828.31
31,0 cm

Atraumatische Gefäßklemmen
Atraumatic Hemostatic Forceps
Pinces hémostatiques atraumatiques
Pinzas hemostáticas atraumáticas
Pinze emostatiche atraumatiche

Atraumatische Mehrzweckklemmen
Atraumatic Multi-Purpose Clamps
Pinces-clamps polyvalentes
Pinzas clamps para usos varios
Pinze atraumatiche per diversi usi



POTTS

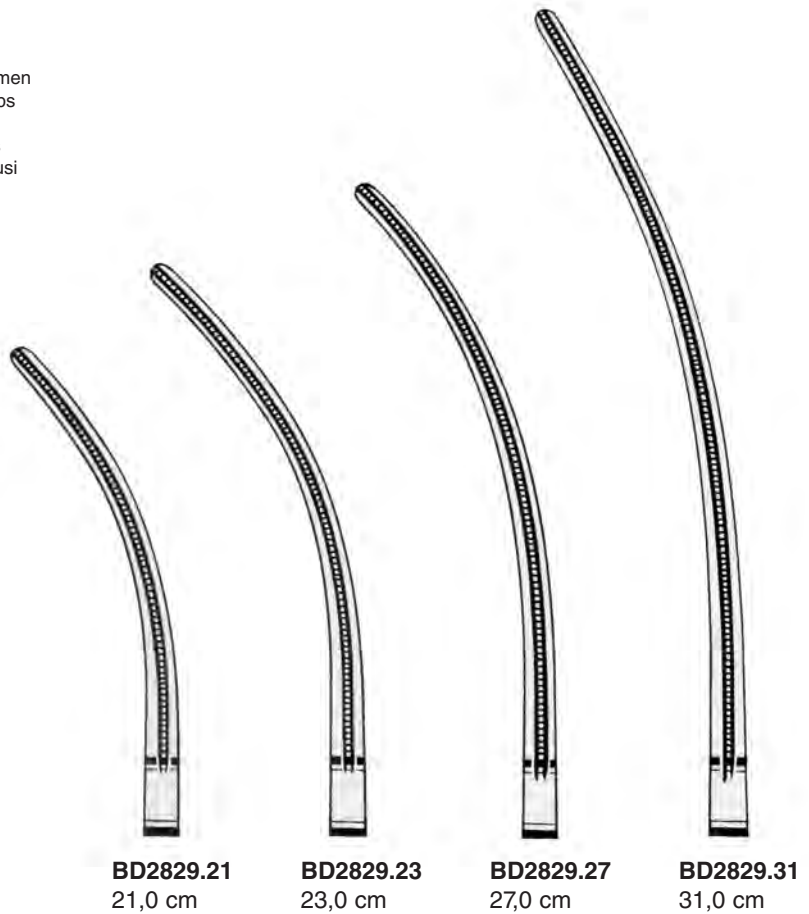

Atraumatische Gefäßklemmen
 Atraumatic Hemostatic Forceps
 Pincés hémostatiques atraumatiques
 Pinzas hemostáticas atraumáticas
 Pinze emostatiche atraumatiche

Anastomosenklemmen, Kindergrößen
 Anastomosis Clamps, Pediatric
 Pincés à anastomose, pédiatriques
 Pinzas para anastomosis, pediátricas
 Pinze per anastomosi, pediatriche

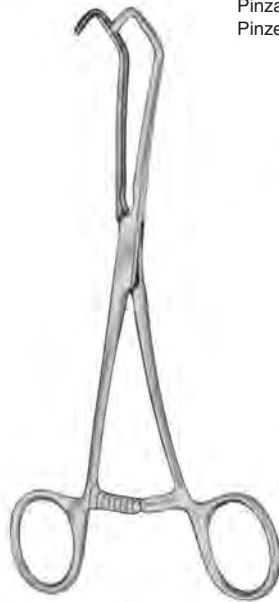

DERRA

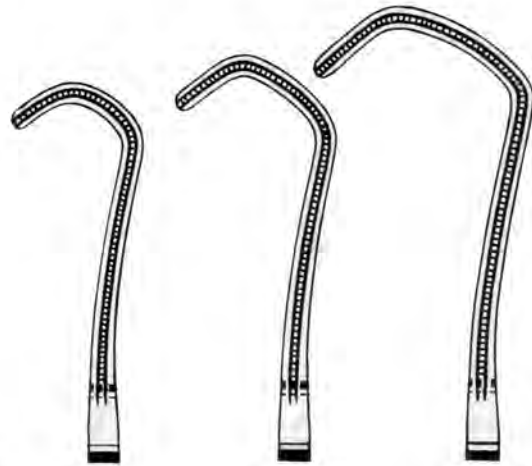

BD2921.16
16,0 cm

BD2921.17
17,0 cm

BD2921.18
18,0 cm

Atraumatische Mehrzweckklemmen
 Atraumatic Multi-Purpose Clamps
 Pincés-clamps polyvalentes
 Pinzas clamps para usos varios
 Pinze atraumatiche per diversi usi

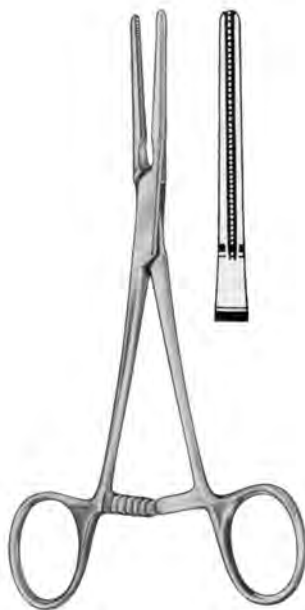

DE BAKEY
BD2032.16
16,0 cm



DE BAKEY
BD2032.17
17,0 cm

Atraumatische Gefäßklemmen
Atraumatic Hemostatic Forceps
Pinces hémostatiques atraumatiques
Pinzas hemostáticas atraumáticas
Pinze emostatiche atraumatiche

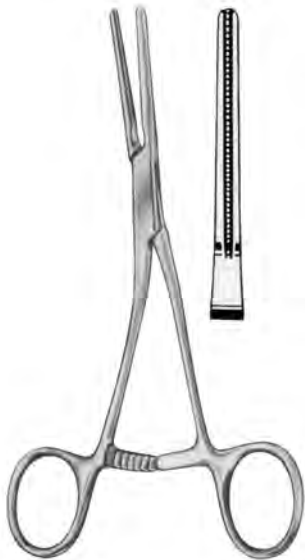

DE BAKEY
BD2033.15
15,0 cm

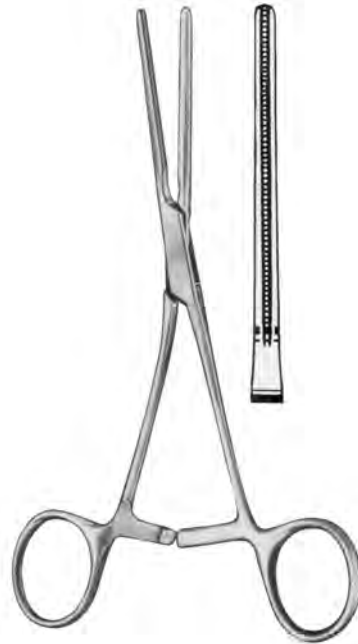

DE BAKEY
BD2037.17
17,0 cm

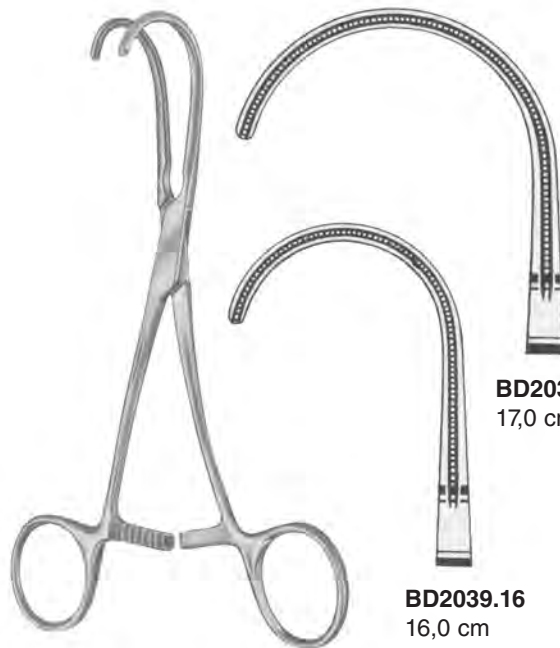

BD2039.17
17,0 cm

BD2039.16
16,0 cm

DE BAKEY

Atraumatische Gefäßklemmen
 Atraumatic Hemostatic Forceps
 Pincés hémostatiques atraumatiques
 Pinzas hemostáticas atraumáticas
 Pinze emostatiche atraumatiche

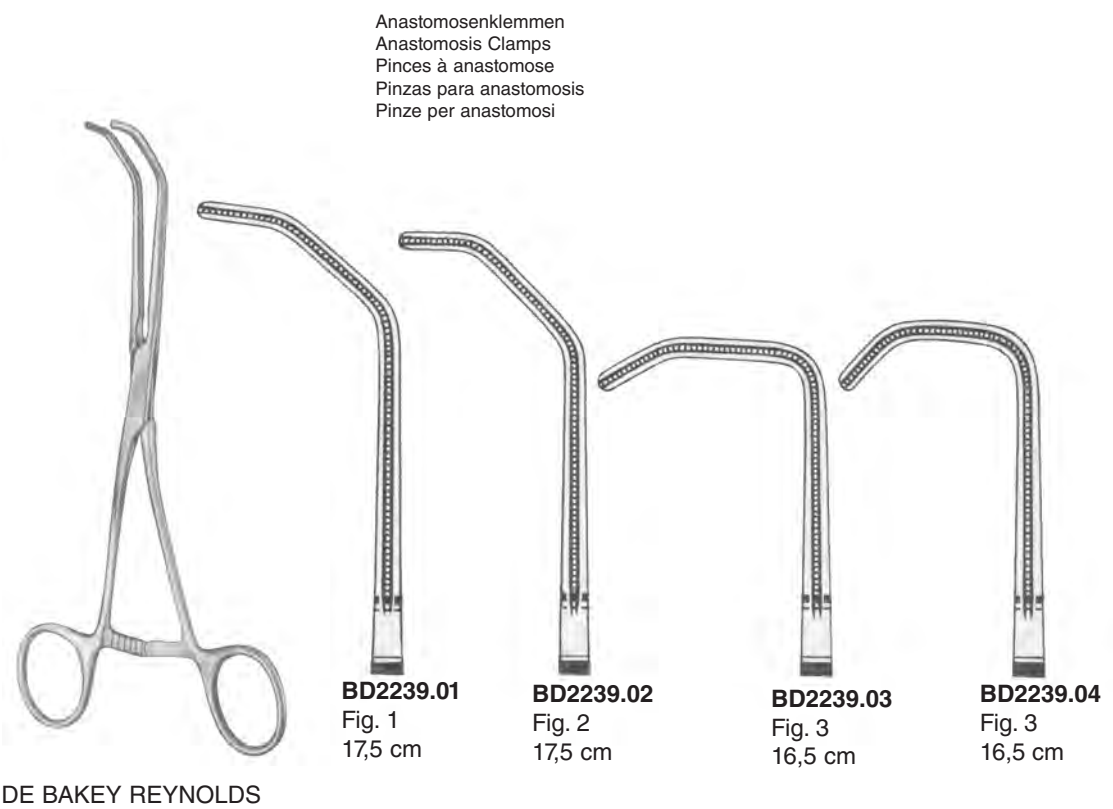
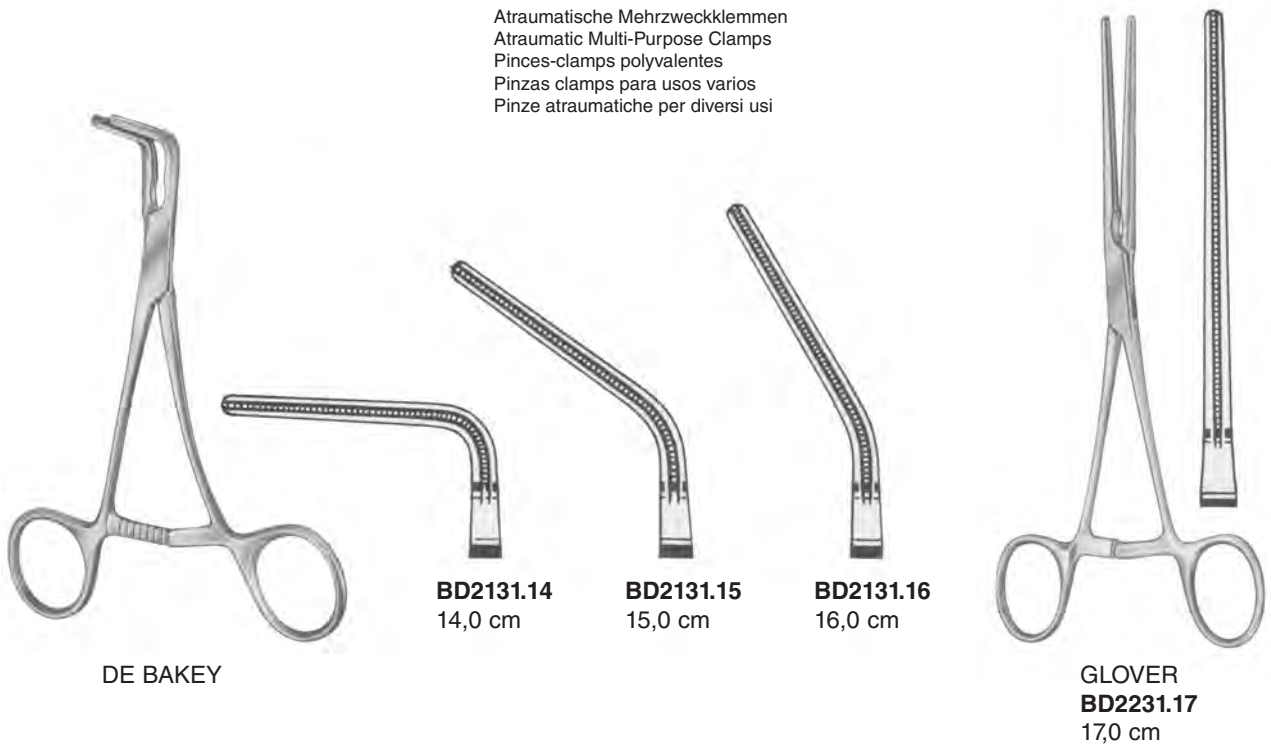

Atraumatische Gefäßklemmen
 Atraumatic Hemostatic Forceps
 Pinces hémostatiques atraumatiques
 Pinzas hemostáticas atraumáticas
 Pinze emostatiche atraumatiche

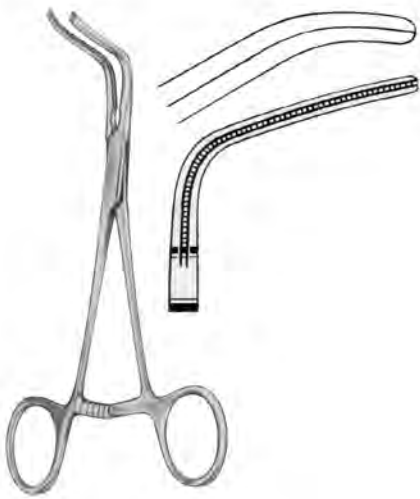

SUBRAMANIAN
BD2331.15
 15,0 cm



SUBRAMANIAN
BD2333.16
 16,0 cm



SUBRAMANIAN
BD2335.16
 16,0 cm



OCHSNER
BD2337.23
 23,0 cm

Aortaklemmen
 Aortic Clamp
 Pince-clamp à aorte
 Pinza clamp para aorta
 Pinza per aorta



DIETRICH
BD2339.21
 21,0 cm

Atraumatische Gefäßklemmen
 Atraumatic Hemostatic Forceps
 Pincés hémostatiques atraumatiques
 Pinzas hemostáticas atraumáticas
 Pinze emostatiche atraumatiche

Präparier- und Ligaturklemmen
 Dissecting and Ligature Clamps
 Pincés à dissection et passe-fil
 Pinzas de disección y para ligaduras
 Pinze per dissezione e per legature



DE BAKEY



BD2431.19
19,0 cm

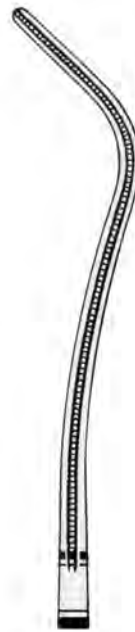

BD2431.20
20,0 cm



BD2431.23
23,0 cm

Carotis-Shuntklemmen
 Carotid Shunt Clamps
 Pincés pour carotide
 Pinzas para shunt carótido
 Pinze carotis



JAVID
BD2433.18
18,0 cm

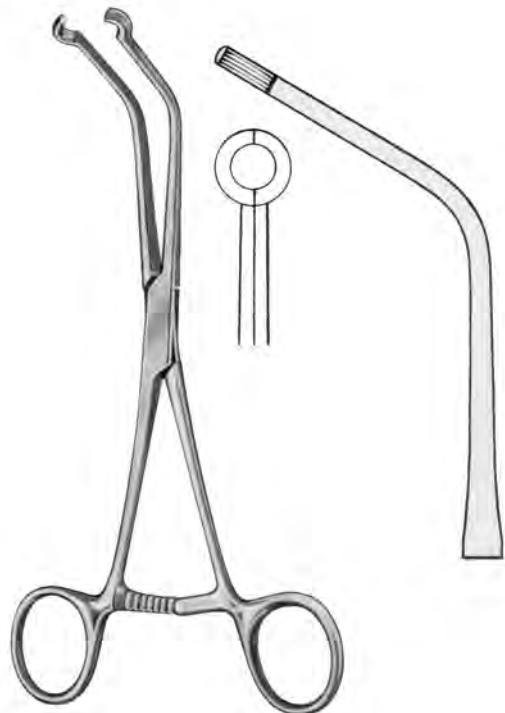

JAVID
BD2433.19
19,0 cm

Atraumatische Gefäßklemmen
 Atraumatic Hemostatic Forceps
 Pincès hémostatiques atraumatiques
 Pinzas hemostáticas atraumáticas
 Pinze emostatiche atraumatiche

Profunda-Klemmen
 Profunda Clamps
 Pincès-clamps pour profunda
 Pinzas clamps para profunda
 Pinze per profunda



GREGORY

BD2439.14
14,0 cm



BD2439.16
16,0 cm

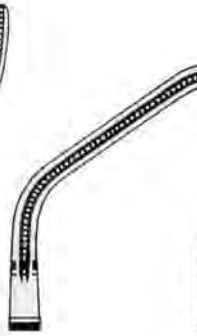

BD2439.18
18,0 cm

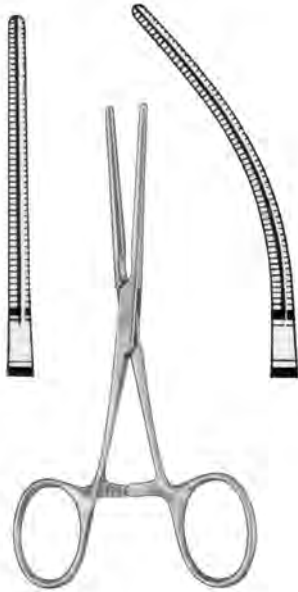
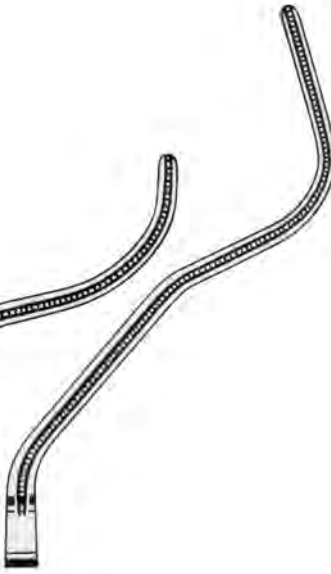

cm
 13,0 **COOLEY**
BD2530.13 **BD2531.13**



COOLEY
BD2533.13
 13,5 cm



COOLEY
BD2535.13
 13,0 cm

Atraumatische Gefäßklemmen
Atraumatic Hemostatic Forceps
Pinces hémostatiques atraumatiques
Pinzas hemostáticas atraumáticas
Pinze emostatiche atraumatiche



COOLEY
BD2537.12
12,5 cm



COOLEY
BD2539.10
10,5 cm

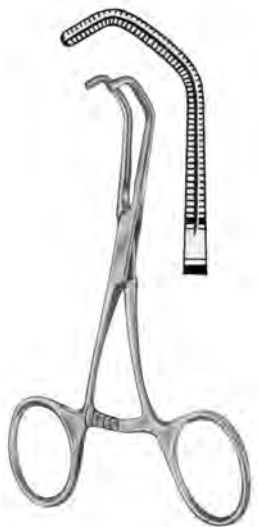

COOLEY
BD2631.12
12,0 cm



COOLEY
BD2633.13
13,5 cm

Atraumatische Gefäßklemmen
 Atraumatic Hemostatic Forceps
 Pincès hémostatiques atraumatiques
 Pinzas hemostáticas atraumáticas
 Pinze emostatiche atraumatiche

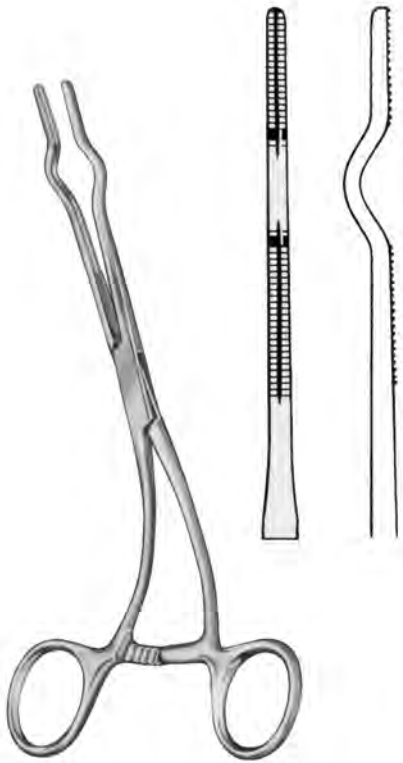

Fr./Charrière	COOLEY
24	BD2731.24
26	BD2731.26
28	BD2731.28
30	BD2733.30
32	BD2733.32
36	BD2733.36

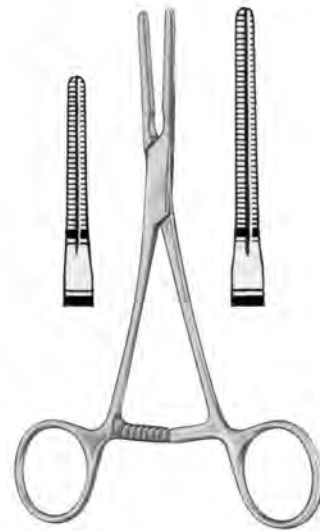

cm	COOLEY	
14,0	BD2736.14	BD2737.14
16,0	BD2736.16	BD2737.16

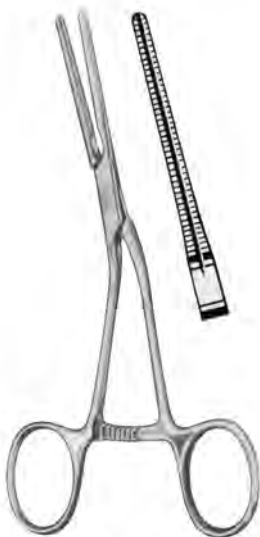

COOLEY
BD2739.14
 14,0 cm

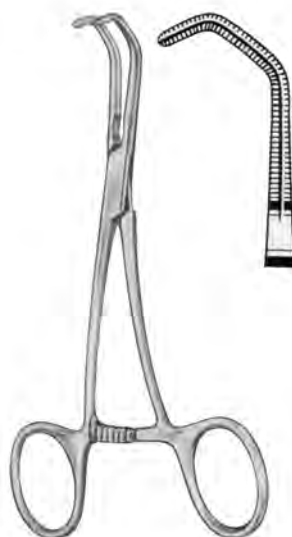

COOLEY
BD2830.14
 14,0 cm



COOLEY
BD2831.14
 14,0 cm

Atraumatische Gefäßklemmen
Atraumatic Hemostatic Forceps
Pincés hémostatiques atraumatiques
Pinzas hemostáticas atraumáticas
Pinze emostatiche atraumatiche



COOLEY
BD2045.27
27,0 cm

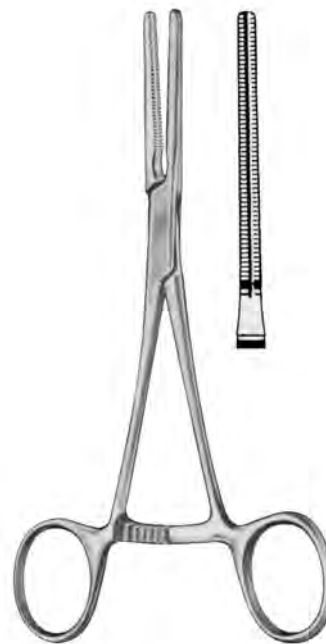

COOLEY
BD2140.17
17,0 cm

Atraumatische Gefäßklemmen
 Atraumatic Hemostatic Forceps
 Pinces hémostatiques atraumatiques
 Pinzas hemostáticas atraumáticas
 Pinze emostatiche atraumatiche

Atraumatische Mehrzweckklemmen
 Atraumatic Multi-Purpose Clamps
 Pinces-clamps polyvalentes
 Pinzas clamps para usos varios
 Pinze atraumatiche per diversi usi

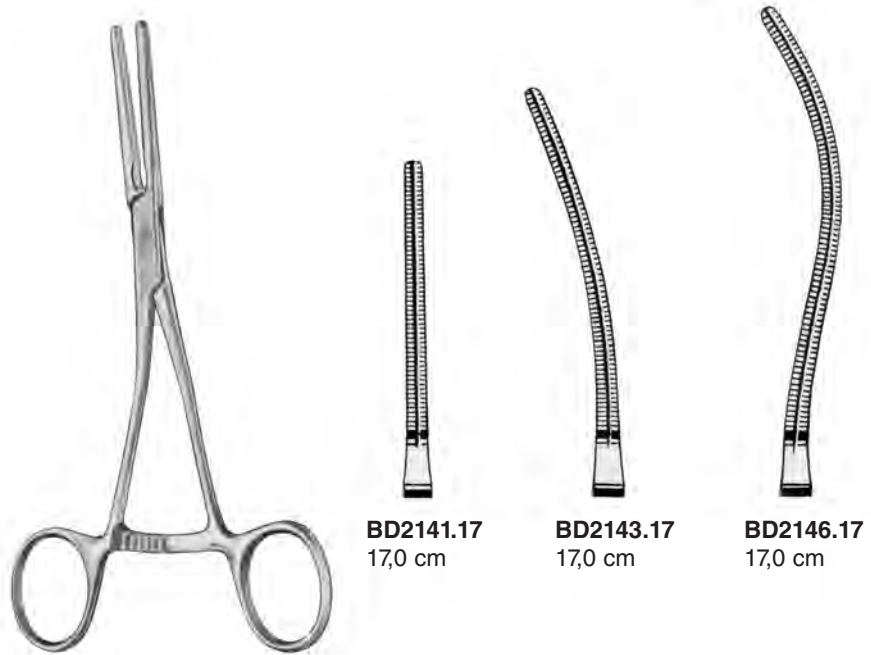

BD2141.17
17,0 cm

BD2143.17
17,0 cm

BD2146.17
17,0 cm

COOLEY

Iliaca-Klemmen
 Iliac Clamps
 Pinces-clamps à iliaque
 Pinzas clamps para iliaca
 Pinze per iliaca



COOLEY
BD2147.21
 21,5 cm

Anastomosenklemmen
 Anastomosis Clamps
 Pinces à anastomose
 Pinzas para anastomosis
 Pinze per anastomosi



COOLEY
BD2149.17
 17,0 cm

Atraumatische Gefäßklemmen
 Atraumatic Hemostatic Forceps
 Pincès hémostatiques atraumatiques
 Pinzas hemostáticas atraumáticas
 Pinze emostatiche atraumatiche

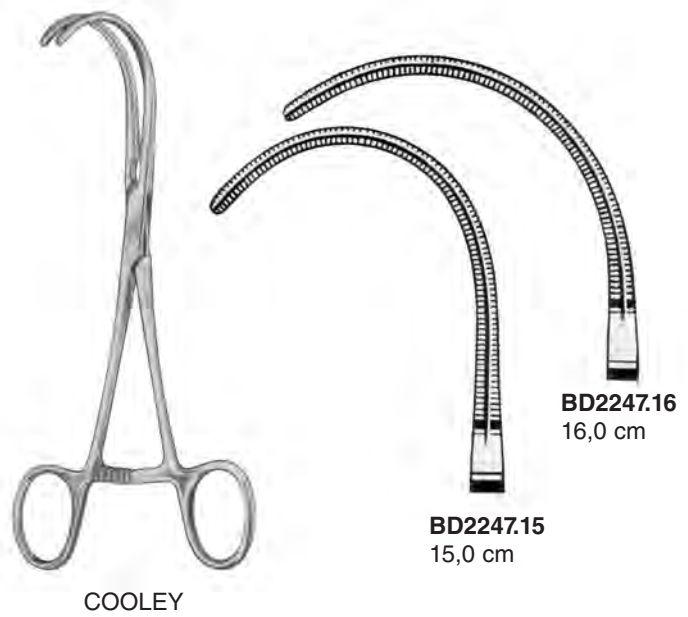

Atraumatische Gefäßklemmen
 Atraumatic Hemostatic Forceps
 Pinces hémostatiques atraumatiques
 Pinzas hemostáticas atraumáticas
 Pinze emostatiche atraumatiche

Atraumatische Mehrzweckklemmen
 Atraumatic Multi-Purpose Clamps
 Pinces-clamps polyvalentes
 Pinzas clamps para usos varios
 Pinze atraumatiche per diversi usi

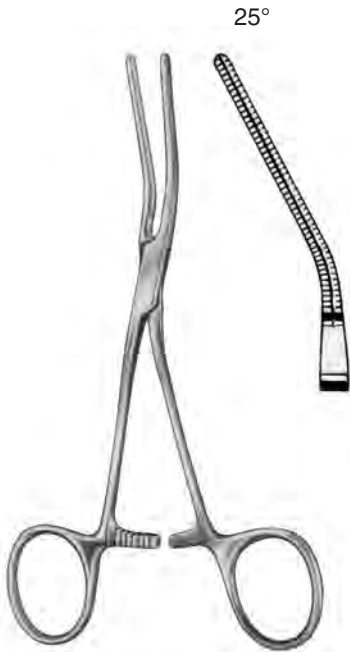

COOLEY
BD2341.25
 16,5 cm

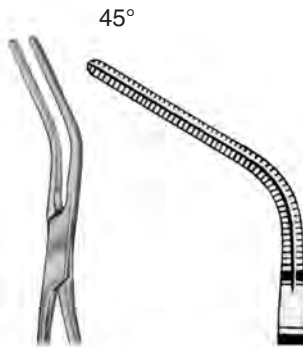

COOLEY
BD2341.45
 16,5 cm

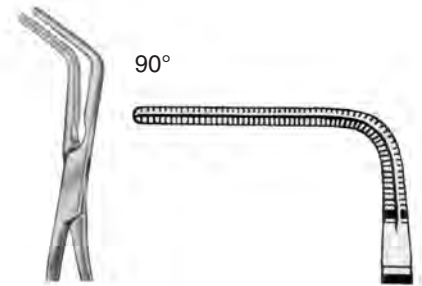

COOLEY
BD2341.90
 16,5 cm

Anastomosenklemmen
 Anastomosis Clamps
 Pinces à anastomose
 Pinzas para anastomosis
 Pinze per anastomosi



COOLEY
BD2343.14
 14,0 cm



COOLEY DERRA

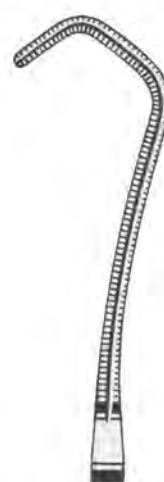

BD2441.16
 16,0 cm



BD2441.17
 17,0 cm

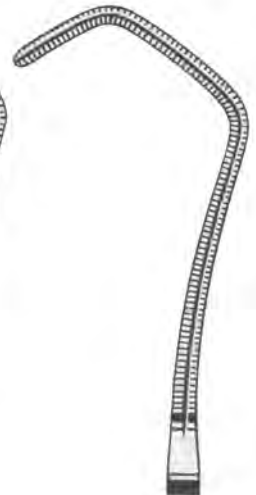

BD2441.18
 18,0 cm

Atraumatische Gefäßklemmen
 Atraumatic Hemostatic Forceps
 Pincés hémostatiques atraumatiques
 Pinzas hemostáticas atraumáticas
 Pinze emostatiche atraumatiche

Anastomosenklemmen
 Anastomosis Clamps
 Pincés à anastomose
 Pinzas para anastomosis
 Pinze per anastomosi



COOLEY
 17,0 cm



BD2447.17
 Fig. 1

BD2449.17
 Fig. 2

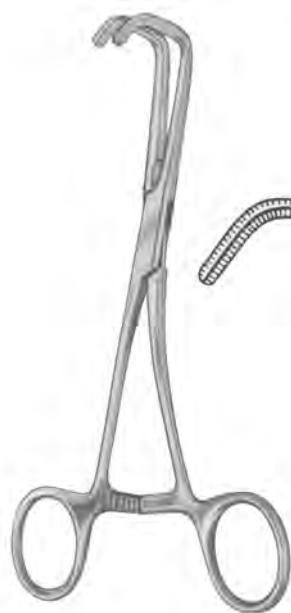

COOLEY

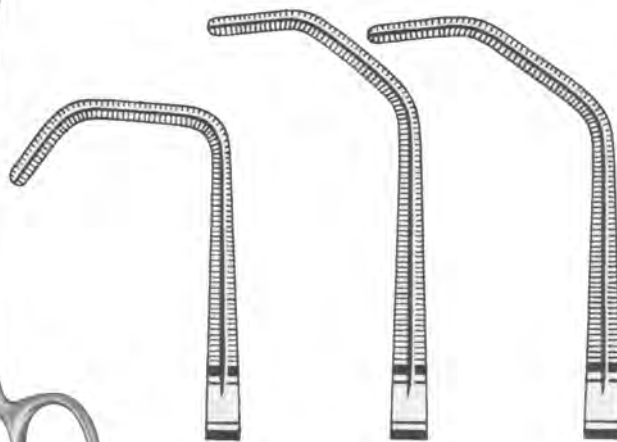

BD2541.16
 16,0 cm

BD2543.16
 17,5 cm

BD2545.17
 17,5 cm

Atraumatische Gefäßklemmen
Atraumatic Hemostatic Forceps
Pinces hémostatiques atraumatiques
Pinzas hemostáticas atraumáticas
Pinze emostatiche atraumatiche



COOLEY
BD2547.17
17,0 cm

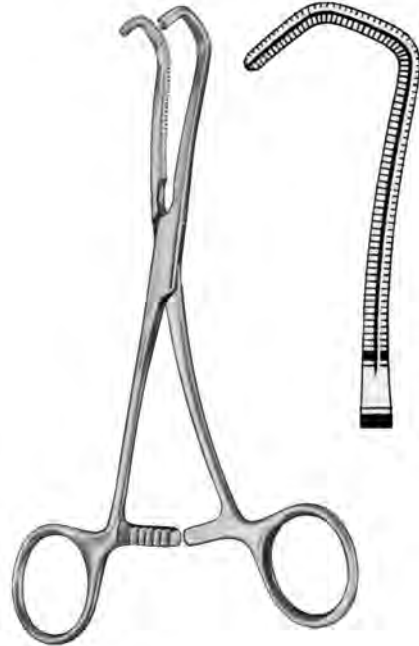

COOLEY
BD2641.17
17,0 cm



COOLEY
BD2645.18
18,0 cm



COOLEY
BD2645.19
19,0 cm

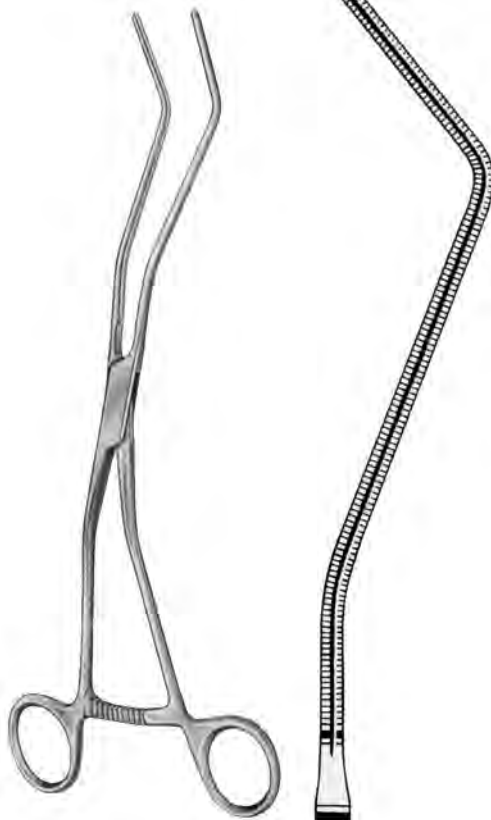

COOLEY
BD2645.26
26,0 cm

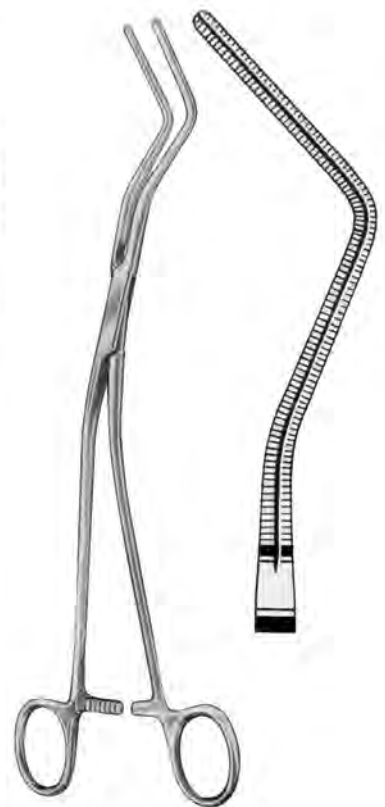

COOLEY
BD2647.27
27,0 cm